

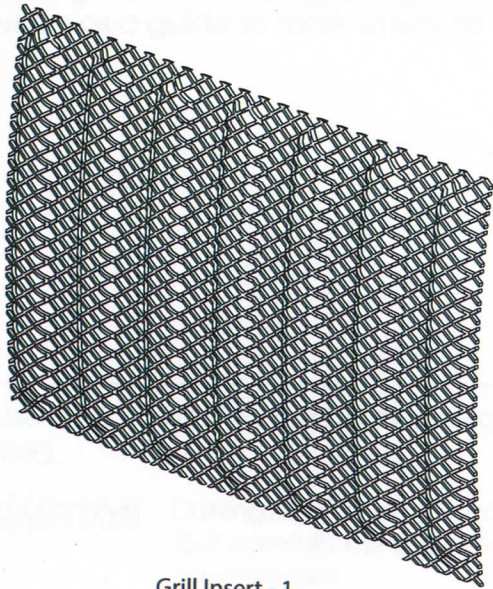

Stainless Steel 11401.21  
Black 11401.31  
Stainless Steel 11401.22  
Black 11401.32

# JEEP® JK GRILL INSERT



Grill Insert - 1



Grill Fasteners - 2



Bolt - 4



Washer - 4



Lock Nut - 4

1. Open vehicle hood, remove grill rivets with a flat tool (e.g. screwdriver). Unplug marker lights. Pull grill off from spring clips attached at bottom of grill. Save components removed.

**NOTICE**

Aftermarket winch and/or bumper may need to be removed.

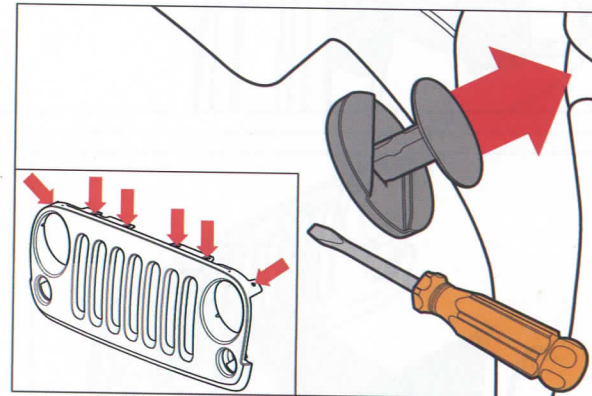

2. Place grill insert and grill fasteners inside grill.

**NOTICE**

Cutout in grill insert should be positioned to the lower side of grill on driver's side. (Circled in Red)

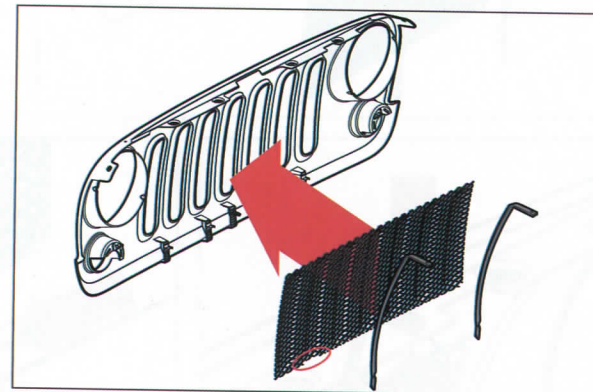

OMIX-ADA® TECHNICAL SUPPORT

PHONE: M-F 8am - 5pm EST 1-800-449-6649 | EMAIL: techsupport@omix-ada.com

FOR WARRANTY INFORMATION VISIT: [www.Omix-Ada.com](http://www.Omix-Ada.com)





## JEEP® JK GRILL INSERT

3. Press grill insert firmly against grill. Use grill fasteners as a guide to mark where to drill.

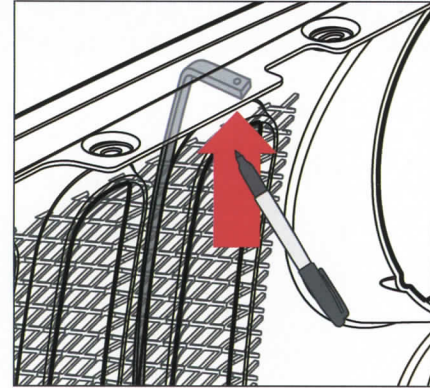
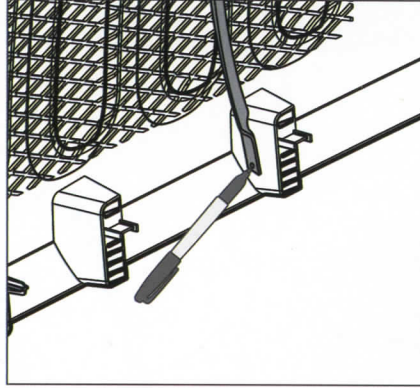

4. Use 3/16" drill bit to cut holes previously marked.



**CAUTION** Cutting/Sharp Edge Hazard:  
Cut carefully using gloves and eye protection.

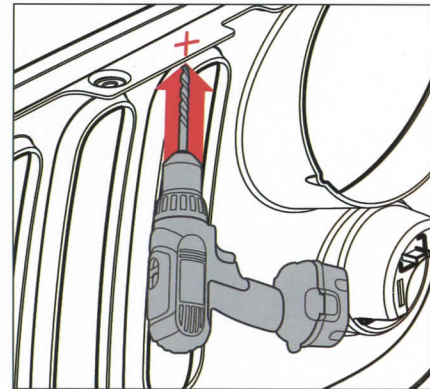
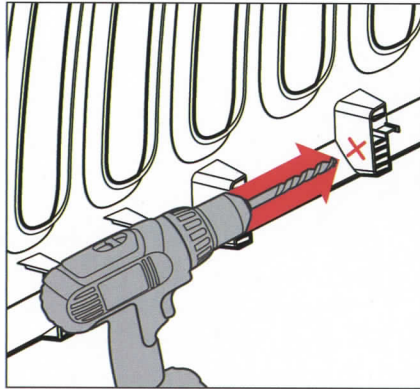

5. Place grill insert and grill fasteners inside grill. With hardware provided, fasten the grill insert. Re-attach grill to vehicle and reconnect marker lights.

