

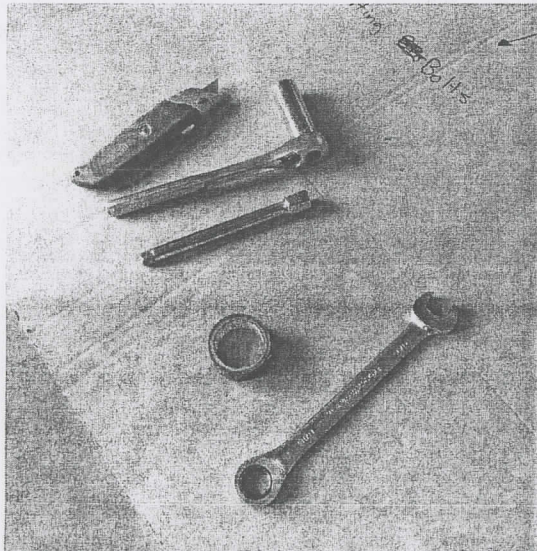

DESTROYER FRONT BUMPER INSTALL

(SHORTY)

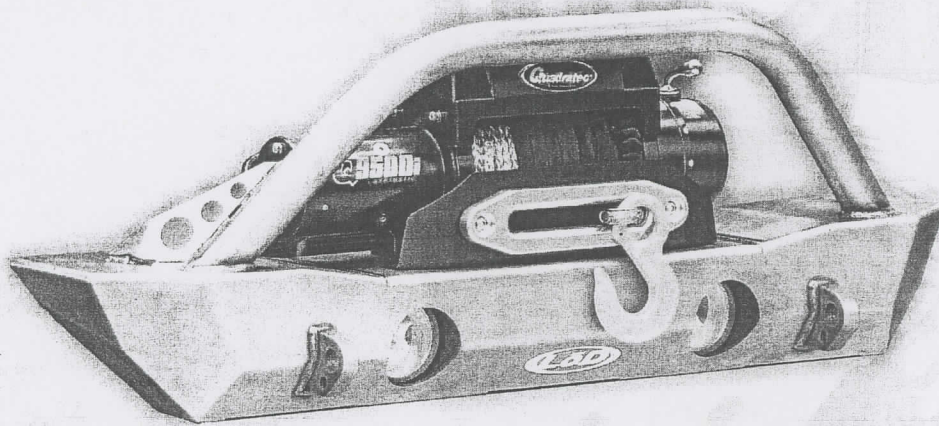

STEP 1: GATHER YOUR TOOLS AND LAY OUT YOUR PARTS...

Tools Required:

- Utility knife
- 11/16" Deep socket
- Ratchet
- 11/16" Crescent wrench
- Ratchet Extension
- 1/4" socket
- Electrical tape

Hardware Provided:

- Eight (7/16"-14 x 1.25") mounting bolts
- Eight (7/16"-14) flange nuts
- Four (7/16") washers
- Eight (#8 Size) screws

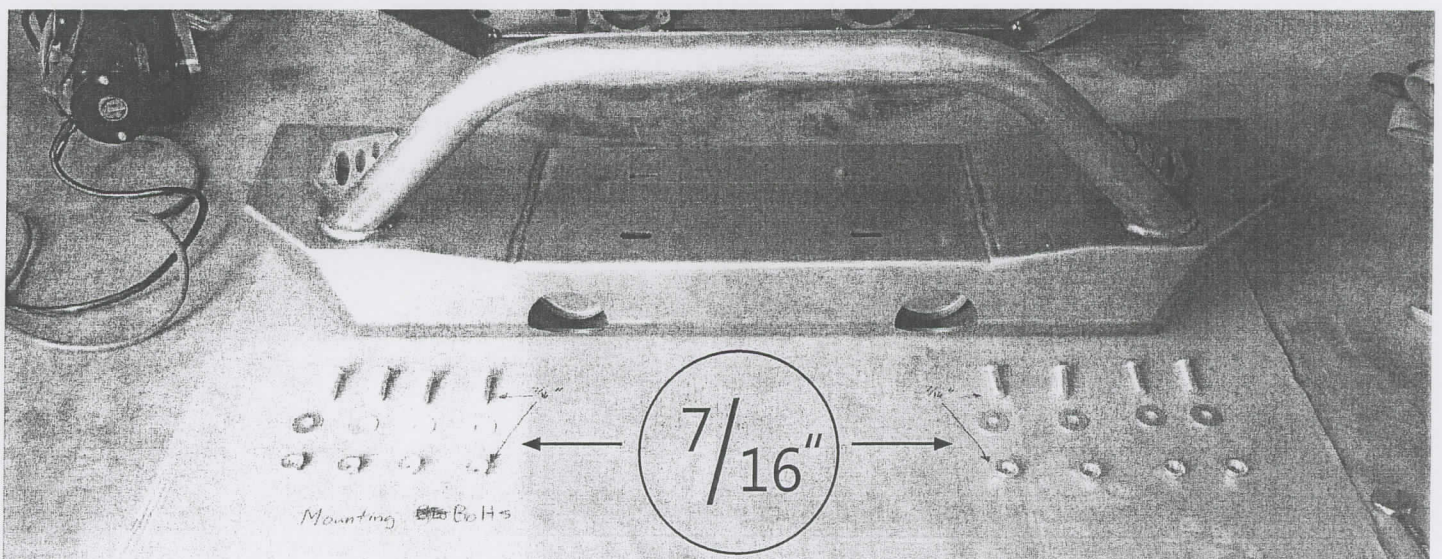

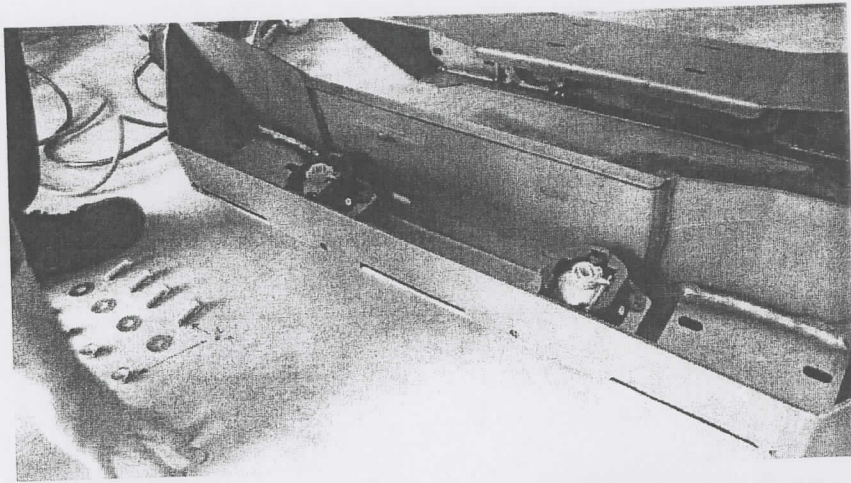

STEP 2 :

TURN THE BUMPER AWAY FROM YOU, AND INSERT THE FACTORY FOGLIGHTS.

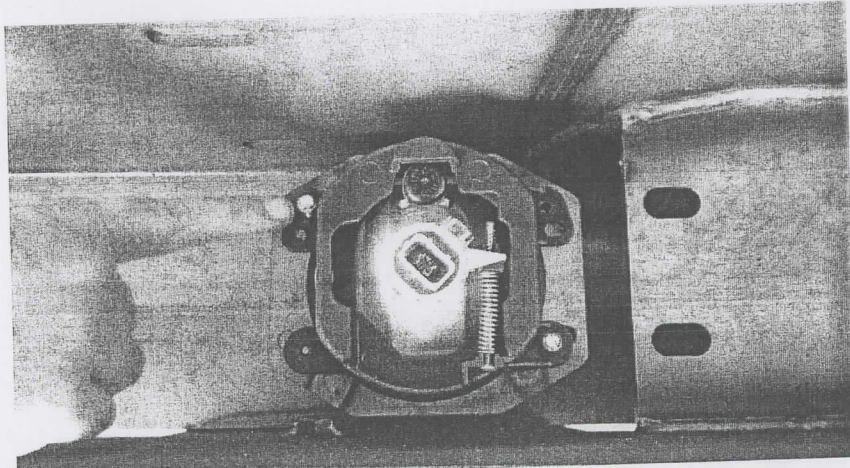

STEP 3 :

LINE UP THE HOLES AND ATTACH THE LIGHTS WITH THE (8) PROVIDED SELF-TAPPING #8 HEX HEAD SCREWS.

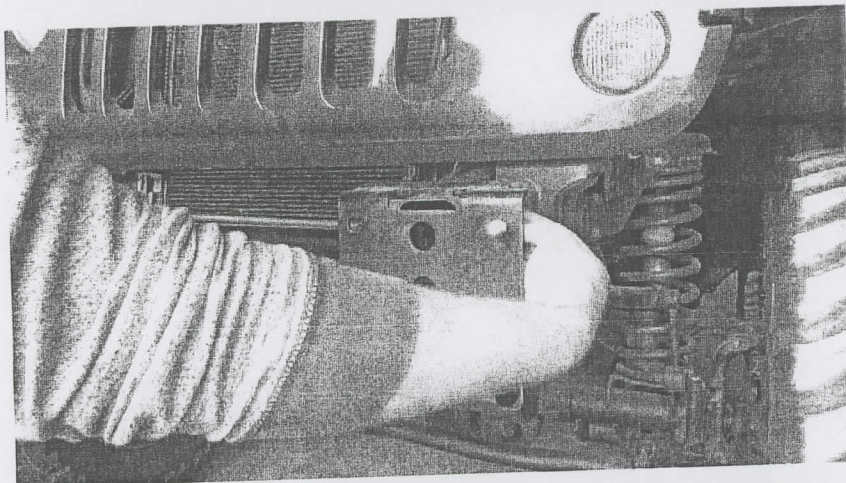

STEP 4 :

START BY INSERTING THE TOP CORNER BOLTS ON EACH SIDE, LEAVING THEM HANGING IN PLACE

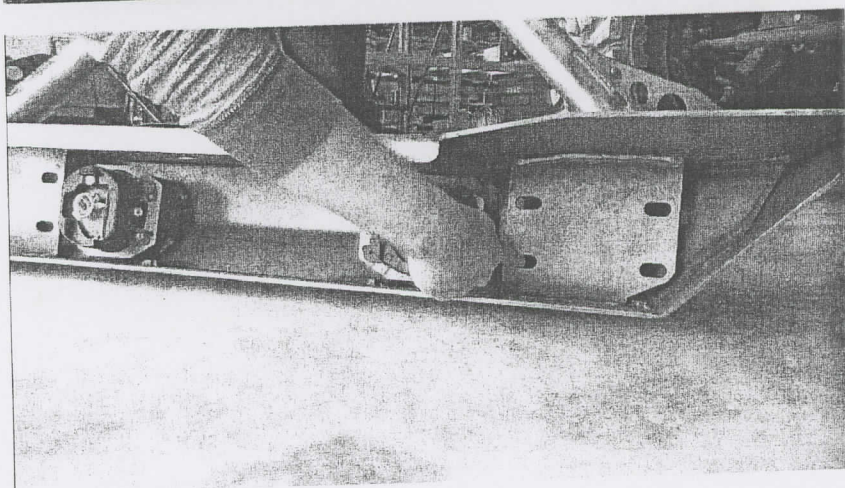

STEP 5 :

LOCATE THE MOUNTING HOLES AND LIFT UP THE BUMPER TO ALIGN THE MOUNTING HOLES ON THE BUMPER AND THE VEHICLE FRAME.

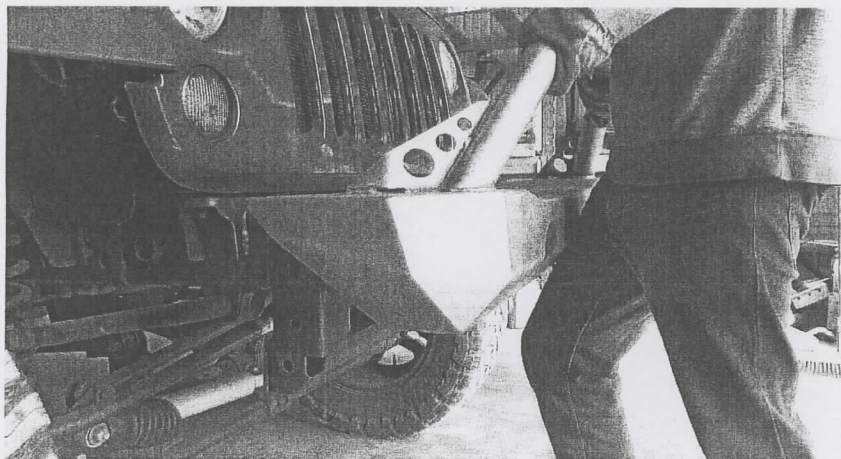

STEP 6 :

GENTLY SLIDE THE BUMPER OVER THE FRAME MOUNTS AND SLOWLY MOVE IT FORWARD, LETTING IT REST ON TOP OF THE FRAME.

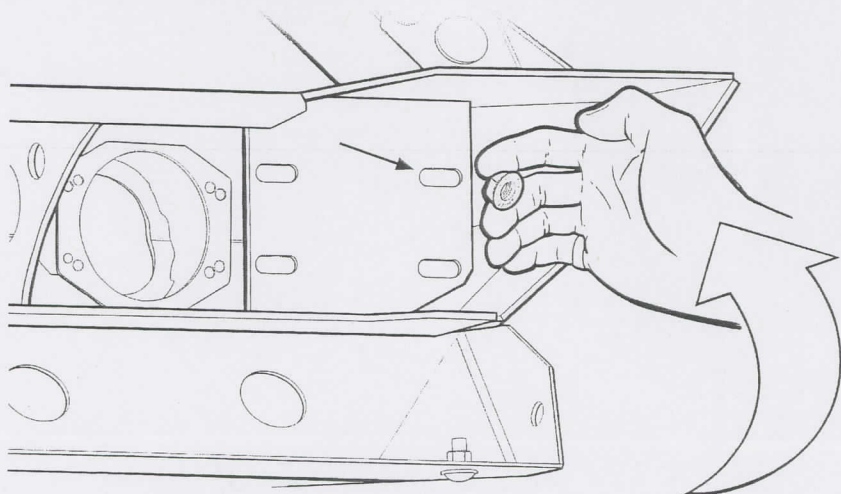

STEP 7 :

HOLD A NUT BETWEEN YOUR FINGERS AND "HOOK" YOUR HAND, REACHING BEHIND THE MOUNT PLATE TO START THE OUTSIDE CORNER BOLTS.

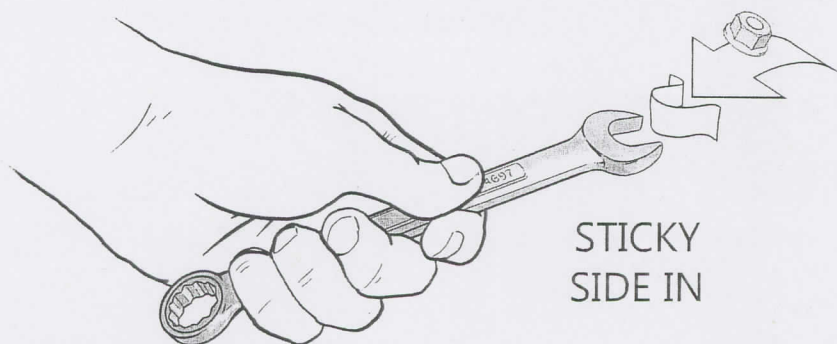

STEP 8 :

GRAB A PIECE OF TAPE AND STICK IT TO THE INSIDE OF THE WRENCH, TO ENSURE THE NUT FITS SNUGLY AND DOES NOT FALL OUT.

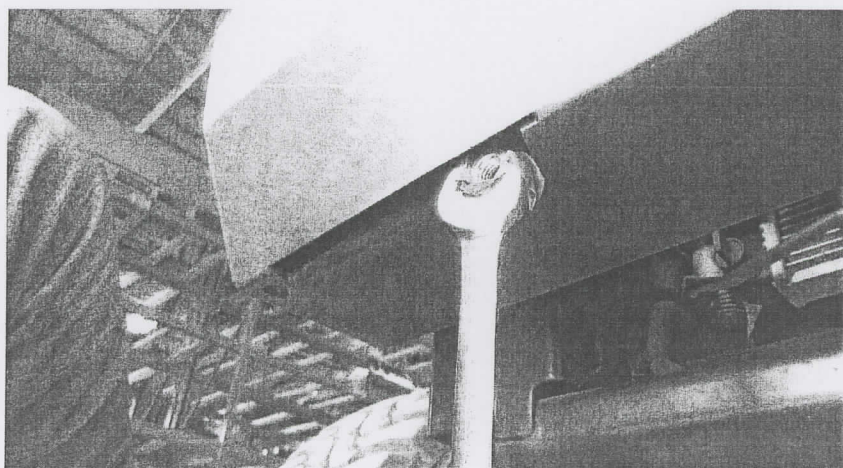

STEP 9 :

PLACE A NUT INTO THE WRENCH, THEN PLACE THE WRENCH INTO THE ACCESS SLOT. ALIGN THE NUT WITH THE TOP CORNER BOLT.

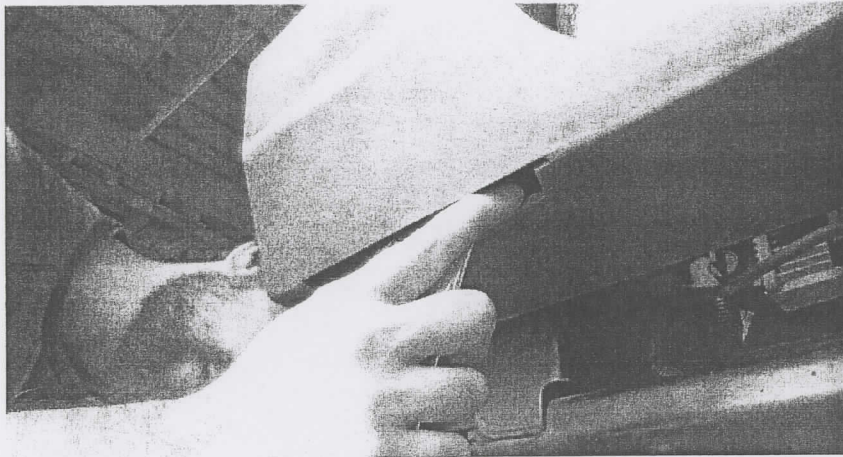

STEP 10 :

ALIGN THE NUT WITH TOP CORNER BOLT YOU INSERTED EARLIER, THEN HAND-TIGHTEN IT.

REPEAT STEPS 7+8 ON THE OPPOSITE CORNER BOLT.

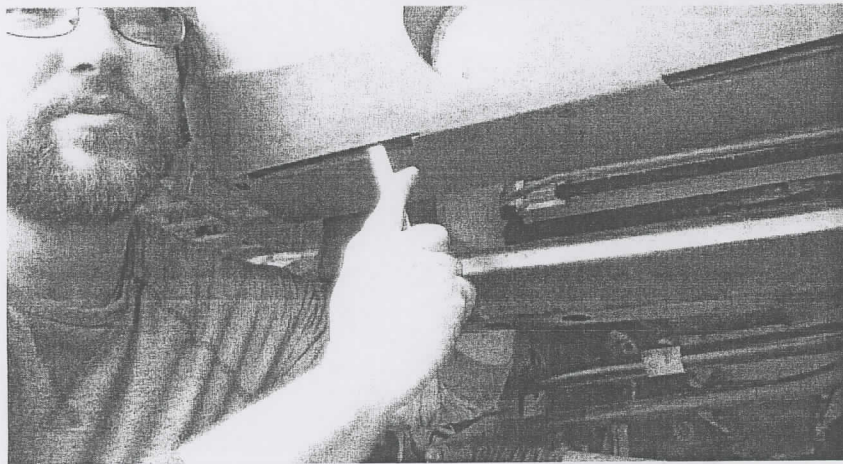

STEP 11 :

- CONTINUE TO USE THE TAPE+WRENCH TO HAND-TIGHTEN THE REST OF THE MOUNTING BOLTS.

- REACH YOUR HAND THROUGH THE BACK OPENINGS TO FEEL FOR THE BOLTS.

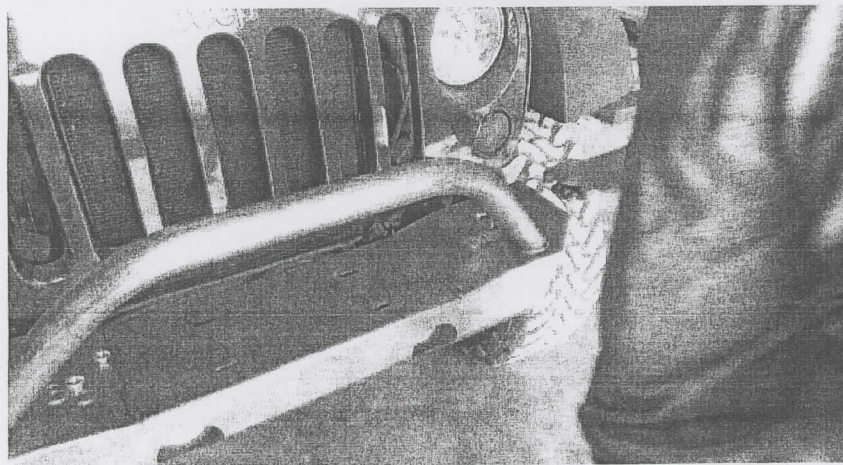

STEP 12 :

- MAKE SURE THE BUMPER IS CENTERED, WITH THE OUTER EDGES MATCHING UP TO THE GRILLE.

-VERTICAL ADJUSTMENTS CAN BE DONE AT THIS TIME, WITH ABOUT 1" OF TRAVEL AVAILABLE

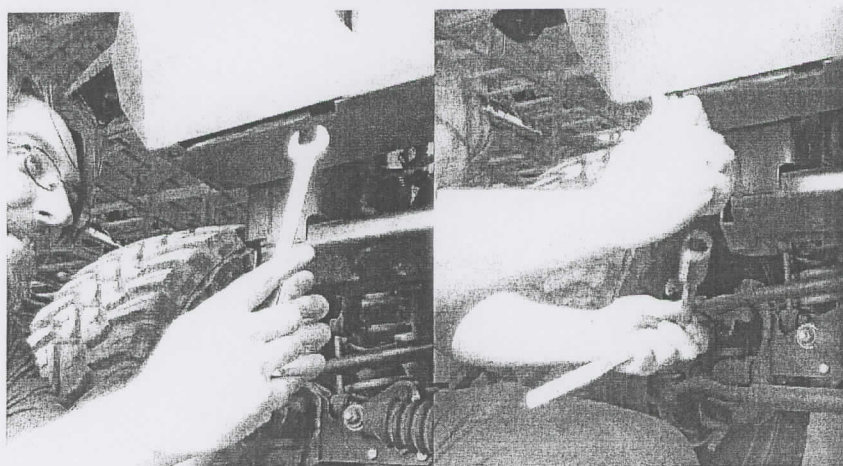

STEP 13 :

- ONCE ALL THE BOLTS ARE HAND-TIGHT, THE TAPE CAN BE REMOVED AND THE WRENCH AND SOCKET CAN BE USED TO TIGHTEN THEM THE REST OF THE WAY.

*IF YOU'RE NOT USING A WINCH, SKIP STEPS 14 - 16.

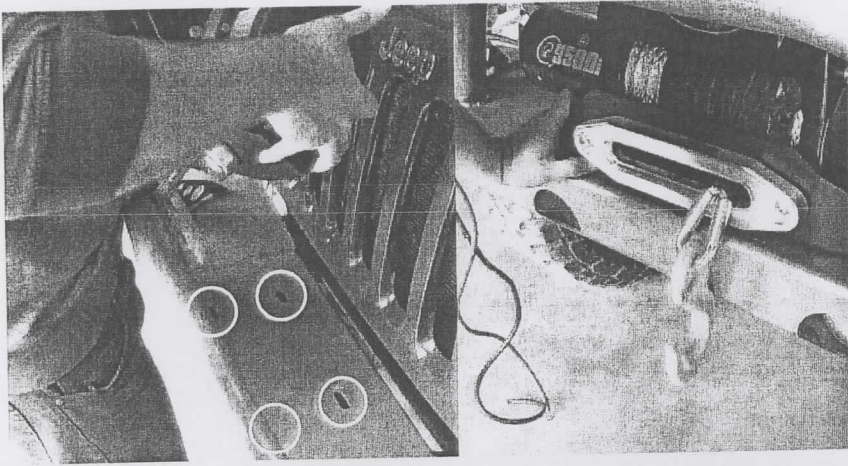

STEP 14 :

- PLACE THE WINCH AND FAIRLEAD OVER THE BULLGUARD AND DOWN ONTO THE BUMPER.

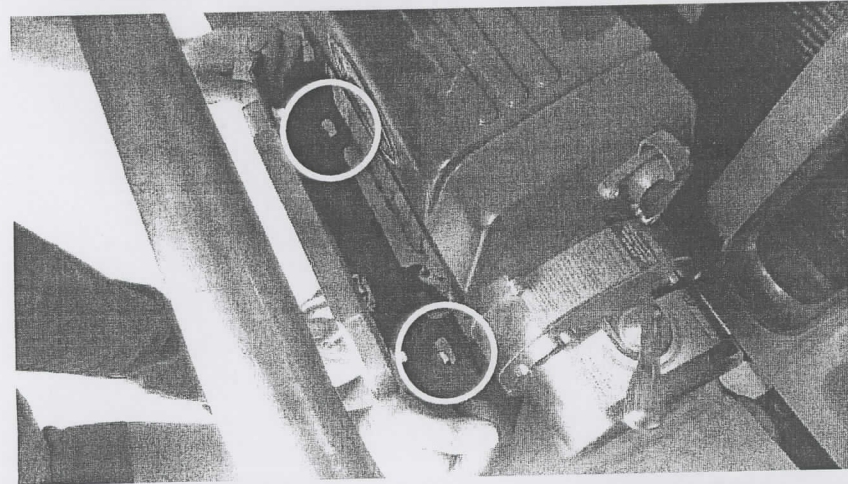

STEP 15 :

- LINE UP THE HOLES IN THE WINCH WITH THE SLOTTED HOLES ON TOP OF THE BUMPER. YOU SHOULD BE ABLE TO SEE DIRECTLY THROUGH THE HOLES.

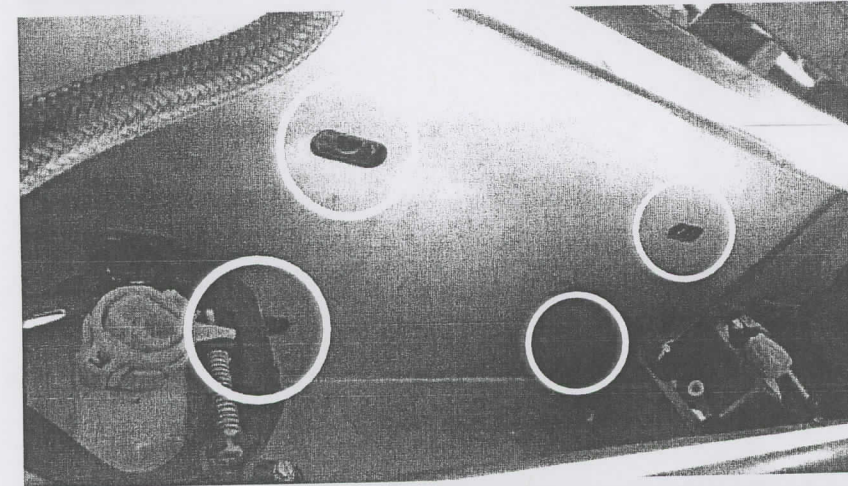

STEP 16 :

- INSERT THE FOUR WINCH MOUNT BOLTS INTO THE OPENINGS AND TIGHTEN THEM DOWN TO SECURE YOUR WINCH IN PLACE.



STEP 17 :

- THIS CONCLUDES THE DESTROYER SERIES SHORTY FRONT BUMPER INSTALLATION, YOUR PRODUCT SHOULD BE MOUNTED AND READY TO USE.

- FOR SKIDPLATE USERS, FOLLOW ACCESSORY DIRECTIONS.

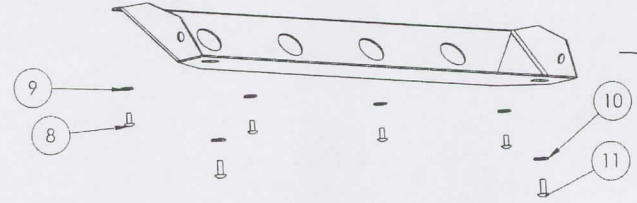
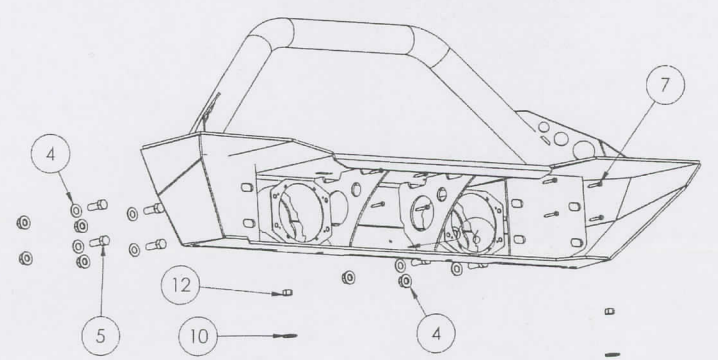
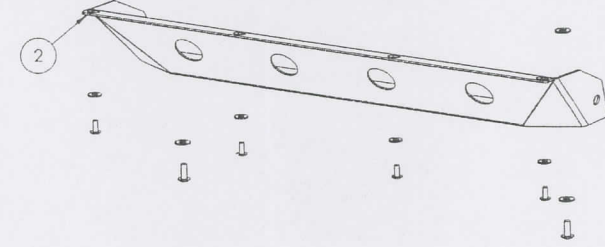
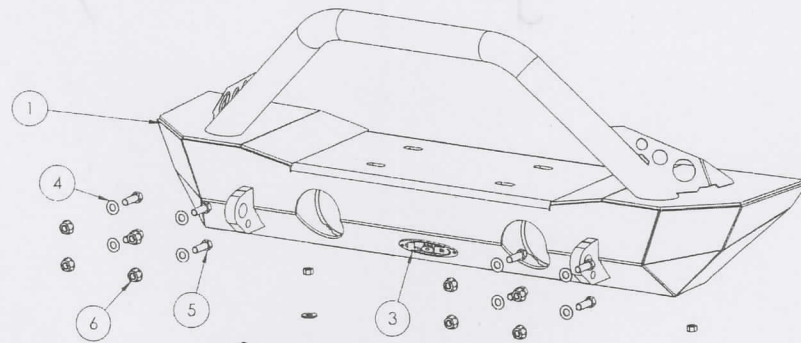

OPTIONAL
SKIDPLATE
SHOWN HERE

Fabricated Assemblies List

ITEM NO.	PART NUMBER	DESCRIPTION	QTY.
1	4JFB1001-01	SHORTY FRONT BUMPER	1
2	4JKS1002	DESTROYER SKID PLATE	1

Hardware Kit List

ITEM NO.	PART NUMBER	DESCRIPTION	QTY.
3	LOD logo	Logo Plate	1
4	Preferred Narrow FW 0.4375	7/16" Washer	8
5	HBOLT 0.4375-14x1.25x1.125-N	7/16" Hex Bolt	8
6	FNUT 0.4375-14-D-N		8
7	hex tapping screw_ai	#8 Self Tap Screw	8
8	HB 0.3125x1	5/16" Buttonhead Bolts	4
9	Preferred Wide FW 0.3125	5/16" Washers	4
10	Preferred Wide FW 0.375	3/8" Washers	4
11	HB 0.375(16) x 1"	3/8" Bolts	2
12	HNO.375(16)	3/8" Hex Nut	2